

## Install Guide for HRN-CM24Y1 + HRN-CI04A2

This harness is designed for Isuzu diesel vehicles 2017 and newer that provide engine data from the FMS port.

**IMPORTANT:** To verify compatibility, ensure that the vehicle is an N-series with RPO code I4H.

The kit part number is 8983519390. See the following table for the individual kit contents and part numbers.

### CAN Interface Converter Kit Part Numbers

Kit Part Number: 8983519390			
NO	Part Number	Part Number	QTY
1	8982222080	Bracket ASM	1
2	0721805200	Screw	4
3	8983002930	Module, CAN Interface Converter	1
4	8983469820	Harness, CAN Interface Converter	1

- 1) Locate CAN Interface Converter harness (P/N 8983469820) in passenger side glove compartment.

**NOTE :** For factory information, you can search for the Isuzu Body Builder Guide on their public website.

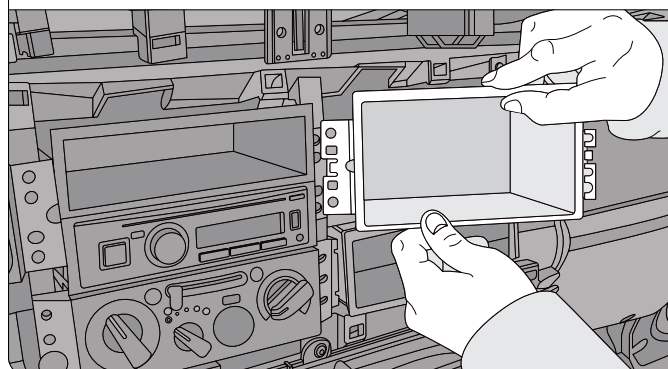
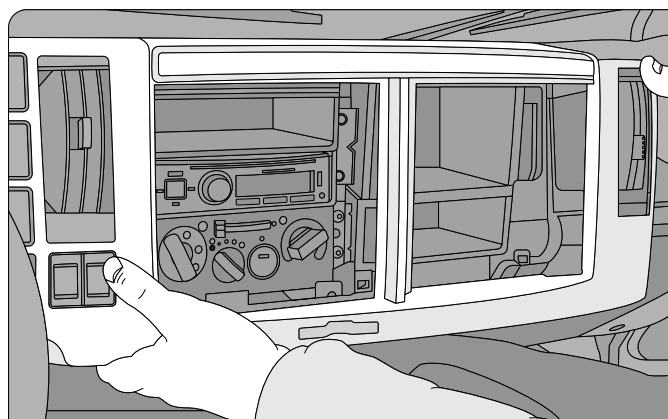
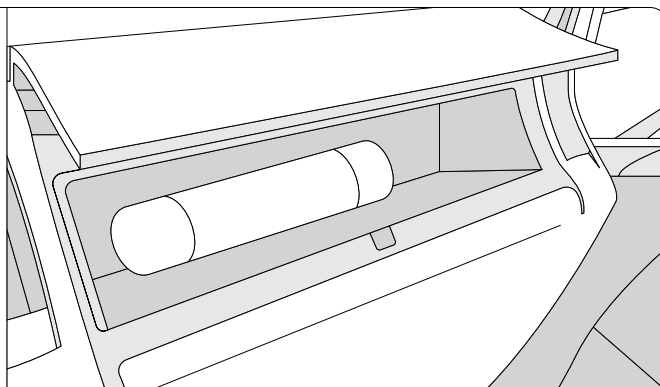

- Step 1:** Remove the dash panel, and then remove the two panels/compartments to the right of the radio.

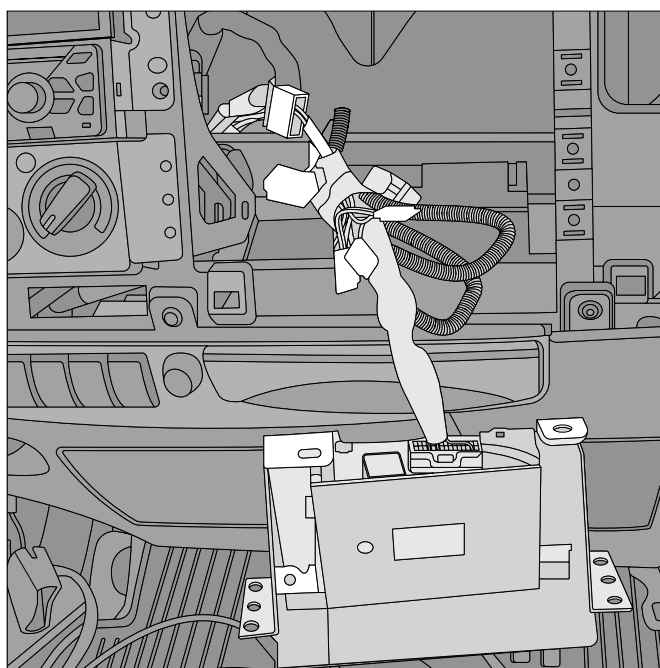

**Step 2 :** Connect the end of the HRN-CI4A2 that is NOT marked OBDII to the FMS module. Next, connect the other end of the HRN-CI4A2 (marked OBDII) to the end of the HRN-CM24Y1 that is also marked OBD-II. See the third picture below.

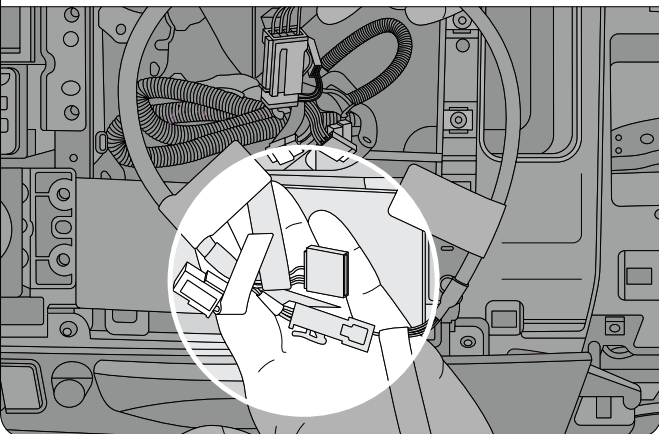
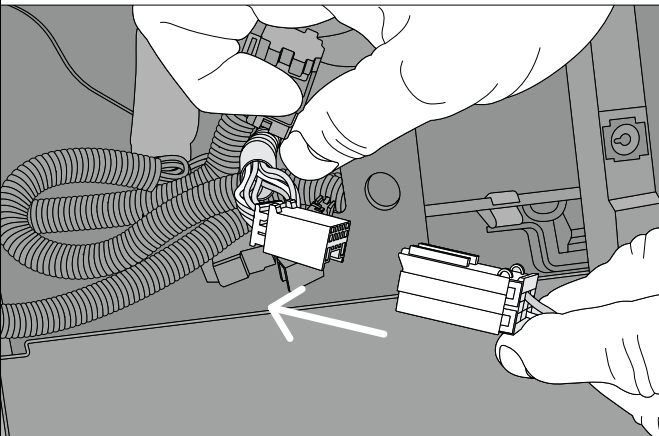
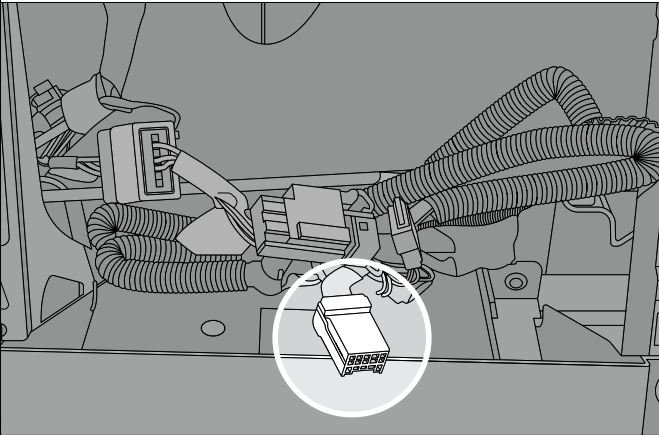

**Step 3 :** Step 3: Once all harnesses have been connected, connect the GO9 device to the HRN-CM24Y1 and use the remaining cable length to mount the GO9 in a suitable location.

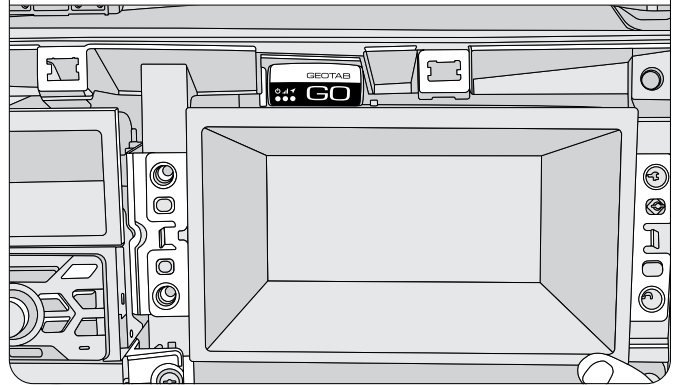
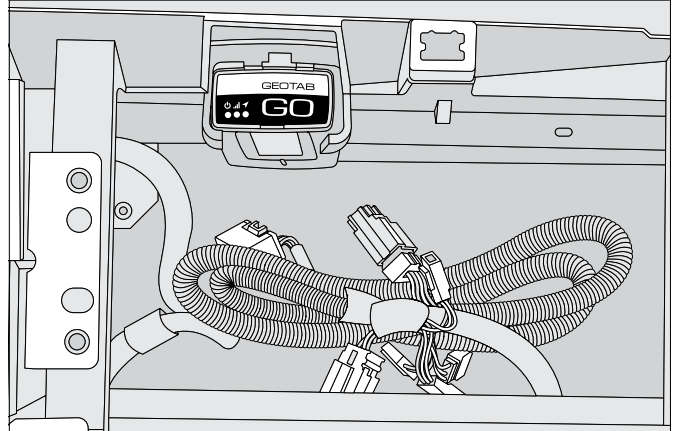

**Step 4 :** Complete an install check for the GO device. Once the install check is done, reinstall all dash panels.

**NOTE :** Ensure the GPS antenna of the GO device is facing skyward.

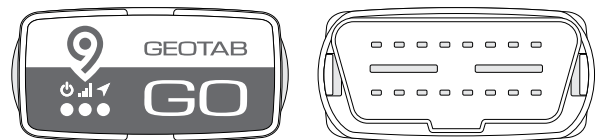

GPS antenna located at "bottom" of device.